

BackLED M Plus G15

LED modules for light advertising and backlighting



Areas of application

- Signage and illuminated advertising
- Backlighting of medium size channel letters
- Backlighting of single and double-sided light boxes
- Permanent outdoor use in enclosed light boxes or channel letters

Product benefits

- Uniform illumination at high LED pitches thanks to Square Lens technology
- Modules are compatible with BackLED mounting profile
- Significantly better application efficiency compared to systems without lenses
- Several options for quick and simple mounting: bolting or snap-in
- Excellent module efficacy
- Very long lifetime
- 5 year guarantee

Product features

- Connected with flexible cables
- Type of protection (modules): IP66
- Color rendering index $R_a > 80$
- Special robust encapsulation
- CE marked and UL listed



Product family datasheet

Technical data

Electrical data

Product description	Nominal voltage	Nominal wattage	Nominal wattage per LED module	Reverse Voltage	Input voltage range	Type of current
BA-M-PL -830	12.0 V	30.00 W	0.75 W	13 V	12...13 V	DC
BA-M-PL -840	12.0 V	30.00 W	0.75 W	13 V	12...13 V	DC
BA-M-PL -865	12.0 V	30.00 W	0.75 W	13 V	12...13 V	DC
BA-M-PL RD	12.0 V	25.00 W	0.62 W	13 V	12...13 V	DC

Photometrical data

Product description	Color temperature	Color rendering index Ra	Light color (designation)	Light color LED	Luminous flux per module chain	Luminous flux per LED module
BA-M-PL -830	3000 K	>80	Warm White	White	2440 lm	61 lm
BA-M-PL -840	4000 K	>80	Daylight	White	2440 lm	61 lm
BA-M-PL -865	6500 K	>80	Cold White	White	2440 lm	61 lm
BA-M-PL RD			Red	Red	920 lm	23 lm

Product description	Luminous efficacy	Standard deviation of color matching	Nominal dominant wavelength
BA-M-PL -830	81 lm/W	≤3 sdcn	
BA-M-PL -840	81 lm/W	≤3 sdcn	
BA-M-PL -865	81 lm/W	≤3 sdcn	
BA-M-PL RD	38 lm/W	≤3 sdcn	625 nm

Light technical data

Product description	Beam angle
BA-M-PL -830	150 °
BA-M-PL -840	150 °
BA-M-PL -865	150 °
BA-M-PL RD	155.00 °

Product family datasheet

LED module information

Product description	Number of LEDs per module	Number of LED modules per chain	Minimum operable number of LED modules
BA-M-PL -830	3	40	1
BA-M-PL -840	3	40	1
BA-M-PL -865	3	40	1
BA-M-PL RD	3	40	1

Dimensions & weight

Product description	Length	Width	Height	Product weight
BA-M-PL -830	8212 mm ¹⁾	12.0 mm	7.1 mm	290.00 g
BA-M-PL -840	8212 mm ¹⁾	12.0 mm	7.1 mm	290.00 g
BA-M-PL -865	8212 mm ¹⁾	12.0 mm	7.1 mm	290.00 g
BA-M-PL RD	8212 mm ¹⁾	12.0 mm	7.1 mm	290.00 g

¹⁾ Maximum LED pitch 200 mm

Product line drawing

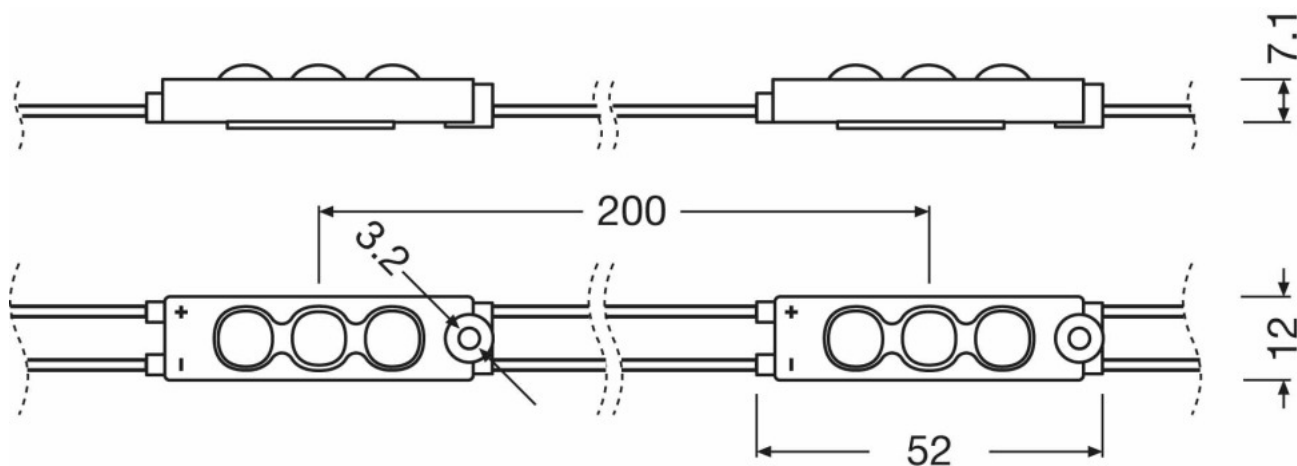

BA-M-PL -830, BA-M-PL -840, BA-M-PL -865, BA-M-PL RD

Product family datasheet

Temperatures & operating conditions

Product description	Temperature range in operation
BA-M-PL -830	-25...55 °C ¹⁾
BA-M-PL -840	-25...55 °C ¹⁾
BA-M-PL -865	-25...55 °C ¹⁾
BA-M-PL RD	-25...55 °C ¹⁾

¹⁾ At the T_c point

Lifespan

Product description	Lifespan
BA-M-PL -830	50000 h ¹⁾
BA-M-PL -840	50000 h ¹⁾
BA-M-PL -865	50000 h ¹⁾
BA-M-PL RD	30000 h

¹⁾ L70/B50 at T_c 75 °C

Capabilities

Product description	Dimmable	Dimming range
BA-M-PL -830	Yes	5...100 %
BA-M-PL -840	Yes	5...100 %
BA-M-PL -865	Yes	5...100 %
BA-M-PL RD	Yes	5...100 %

Certificates & standards

Product description	Energy consumption	Energy efficiency class	Type of protection
BA-M-PL -830	3 kWh/1000h	A+	IP66
BA-M-PL -840	3 kWh/1000h	A+	IP66
BA-M-PL -865	3 kWh/1000h	A+	IP66
BA-M-PL RD	3 kWh/1000h	A	IP66

Product description	Standards
BA-M-PL -830	Acc. to IEC 62031/Acc. to IEC 62471/Acc. to CISPR 15/Acc. to IEC 61547/Acc. to EN 60529
BA-M-PL -840	Acc. to IEC 62031/Acc. to IEC 62471/Acc. to CISPR 15/Acc. to IEC 61547/Acc. to EN 60529
BA-M-PL -865	Acc. to IEC 62031/Acc. to IEC 62471/Acc. to CISPR 15/Acc. to IEC 61547/Acc. to EN 60529
BA-M-PL RD	Acc. to IEC 62031/Acc. to IEC 62471/Acc. to CISPR 15/Acc. to IEC 61547/Acc. to EN 60529

Product family datasheet

Logistical data

Product description	Temperature range at storage
BA-M-PL -830	-25...85 °C
BA-M-PL -840	-25...85 °C
BA-M-PL -865	-25...85 °C
BA-M-PL RD	-25...85 °C

Equipment / Accessories

- BackLED mounting profile BA-SM-MP
- Several types of OPTOTRONIC 12 V power supplies available









Application advice

For more detailed application information and graphics please see product datasheet.

Sales and Technical Support

Sales and Technical Support www.osram.com

Download Data

File	
	Brochures Technical application guide - IP codes in accordance with IEC 60529 (GB)
	Brochures Impressive backlighting for signage and presentation (GB)
	Brochures Technical application guide BackLED PlusBasic G15 and BoxLED Plus G15 (GB)
	Certificates MD-DoC BackLED SM Plus G15
	Declarations of conformity EC-DoC BackLED SM Plus G15
	Installation/Operation notice Instruction guide BackLED S M L Plus G15 G10569011
	Installation guide Instruction Manual BackLED SML Plus G15
	CAD data CAD Daten BA-M-PL G15_IGS
	CAD data CAD Daten BA-M-PL G15_STEP

Product family datasheet



CAD data 3-dim
BackLED M Plus G15 IGS



CAD data 3-dim
BackLED M Plus STEP



CAD data PDF
CAD Daten BA-M-PL G15_pdf

Logistical Data

Product code	Product description	Packaging unit (Pieces/Unit)	Dimensions (length x width x height)	Volume	Gross weight
4052899300538	BA-M-PL -830	Shipping carton box 5	488 mm x 254 mm x 223 mm	27.64 dm ³	3456.00 g
4052899300514	BA-M-PL -840	Shipping carton box 5	488 mm x 254 mm x 223 mm	27.64 dm ³	3456.00 g
4052899300491	BA-M-PL -865	Shipping carton box 5	488 mm x 254 mm x 223 mm	27.64 dm ³	3456.00 g
4052899300552	BA-M-PL RD	Shipping carton box 5	488 mm x 254 mm x 223 mm	27.64 dm ³	3456.00 g

The mentioned product code describes the smallest quantity unit which can be ordered. One shipping unit can contain one or more single products. When placing an order, for the quantity please enter single or multiples of a shipping unit.

Accessories Optional

Product description	Accessory name	Accessory code
BA-M-PL 830 G15	BackLED, -SM-MP	▶ 4052899264557
BA-M-PL 840 G15	BackLED, -SM-MP	▶ 4052899264557
BA-M-PL 865 G15	BackLED, -SM-MP	▶ 4052899264557
BA-M-PL RED G15	BackLED, -SM-MP	▶ 4052899264557

References / Links

For more information on the multi-level guarantee and the terms and conditions of the guarantee visit

▶ www.osram.com/system-guarantee

Disclaimer

Subject to change without notice. Errors and omission excepted. Always make sure to use the most recent release.