

BackLED DS Plus G15

LED modules for light advertising and backlighting

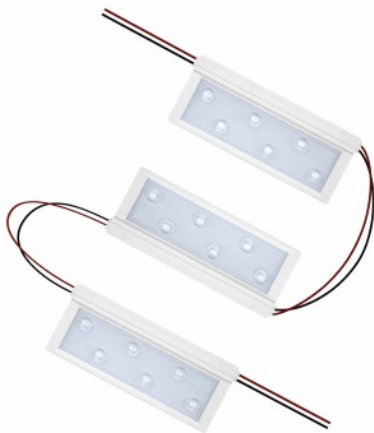

Areas of application

- Signage and illuminated advertising
- Backlighting of double-sided light boxes and pylons
- Permanent outdoor use in enclosed light boxes

Product benefits

- Uniform illumination at high LED pitches thanks to Flat Ray technology
- Modules compatible with the BoxLED DS mounting profile
- Click and Play: quick and easy click-in of the LED modules, no tools needed
- Excellent module efficacy
- Very long lifetime
- 5 year guarantee

Product features

- Connected with flexible cables
- Type of protection (modules): IP66
- Color rendering index R_a : > 80
- Special robust encapsulation
- CE marked and UL listed



Product family datasheet

Technical data

Electrical data

Product description	Nominal voltage	Nominal wattage	Nominal wattage per LED module	Reverse Voltage	Input voltage range
BA-DS-PL -865	24.0 V	100.0 W	6.2 W	25 V	23...25 V

Photometrical data

Product description	Color temperature	Color rendering index Ra	Light color (designation)	Light color LED	Luminous flux per module chain	Luminous flux per LED module
BA-DS-PL -865	6500 K	>80	Cool White	White	9760 lm	610 lm ¹⁾

Product description	Luminous efficacy	Standard deviation of color matching
BA-DS-PL -865	98 lm/W	≤3 sdcM

¹⁾ 305 lm on each side

Light technical data

Product description	Beam angle
BA-DS-PL -865	155 °

LED module information

Product description	Number of LEDs per module	Number of LED modules per chain	Minimum operable number of LED modules
BA-DS-PL -865	12	16	1

Dimensions & weight

Product description	Length	Width	Height	Product weight
BA-DS-PL -865	6400 mm ¹⁾	56.0 mm	12.1 mm	1304.00 g ²⁾

¹⁾ Maximum LED pitch 400 mm

²⁾ Per chain

Product family datasheet

Product line drawing

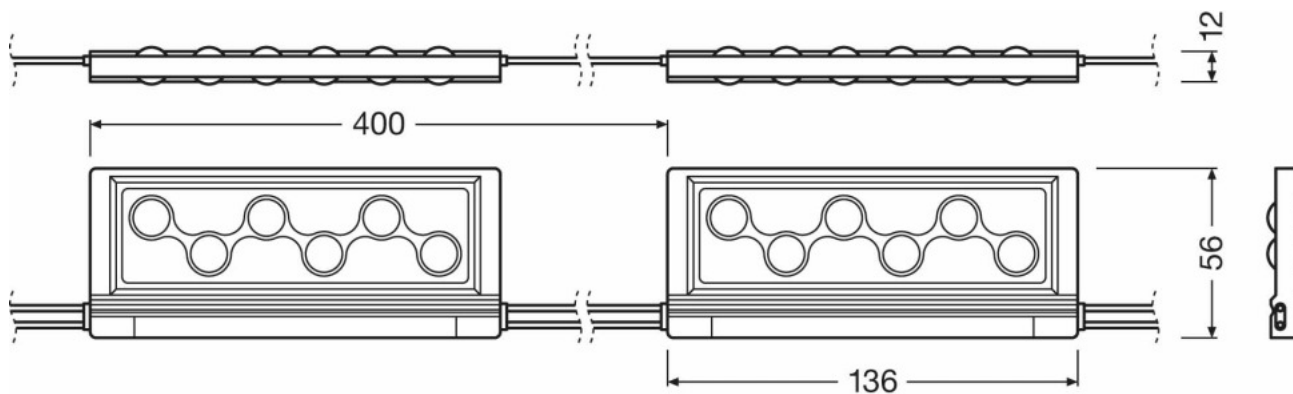

BA-DS-PL -865

Temperatures & operating conditions

Product description	Temperature range in operation
BA-DS-PL -865	-25...80 °C ¹⁾

¹⁾ At the T_c point

Lifespan

Product description	Lifespan
BA-DS-PL -865	50000 h ¹⁾

¹⁾ L70/B50 at T_c max. 80 °C

Capabilities

Product description	Dimmable	Dimming range
BA-DS-PL -865	Yes	5...100 %

Product family datasheet

Certificates & standards

Product description	Energy consumption	Energy efficiency class	Type of protection
BA-DS-PL -865	7 kWh/1000h	A	IP66

Product description	Standards
BA-DS-PL -865	Acc. to EN 55015/Acc. to EN 61347-2-13/Acc. to EN 61547/Acc. to EN 61000-3-2

Logistical data

Product description	Temperature range at storage
BA-DS-PL -865	-25...85 °C

Light Distribution

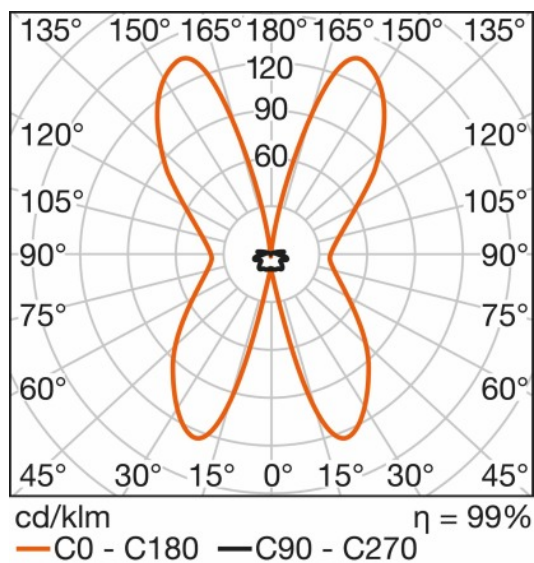

BA-DS-PL -865

Equipment / Accessories

- Several types of OPTOTRONIC 24 V power supplies available
- BoxLED Back Plus DS mounting profile
- BoxLED Back Plus DS mounting brackets

Product family datasheet

Application advice

For more detailed application information and graphics please see product datasheet.

Additional product information

- Installation of LED modules (with power supplies) needs to be made under consideration of all valid regulations and norms.
 - Installation by qualified electrician only.
 - Please see the relevant application guides and instructions sheets for more detailed safety and mounting information. Additional information is available on request.
 - Complies with IEC/EN 61547
 - Complies with IEC/EN 61000-3-2
 - Complies with EN 55015, CISPR 15
 - Complies with IEC/EN 61347-1
 - Complies with IEC/EN 61347-2-13
 - LED modules are dimmable by means of PWM (pulse width modulation). It is recommended using the following OSRAM control gears: OPTOTRONIC OT DIM or OPTOTRONIC 24 V power supplies with integrated 1...10 V dimming interface.
 - Parallel connection is mandatory for safe electrical operation. Serial connection of LED modules is strongly discouraged. Unbalanced voltage drop in serial connection can cause hazardous overload and damage the LED module.
 - Electrical contact is achieved with the contact cables or the terminals of the module. Please refer to the technical data for maximum number of LED modules that can be operated on one control gear.
 - In order to operate OSRAM LED modules safely, it is absolutely necessary to operate them with an electronically stabilized power supply that protects against short circuits, overload and overheating.
 - In case other power supplies than OSRAM OPTOTRONIC are used, compliance to the necessary operating parameters (voltage, current, power) has to be ensured.
 - Pay attention to polarity! Wrong polarity can cause destruction or malfunction of the module.
 - Conducting paths on the circuit board must not be damaged or destroyed during installation.
 - The LED module itself and all its components must not be stressed mechanically.
 - Operation in or under water is prohibited.
 - To avoid mechanical damage, the LED modules have to be attached securely to the intended mounting surface. It is recommended to avoid heavy vibration.
 - In case that the LED module is equipped with a pre-mounted double-sided adhesive tape, OSRAM assumes no liability and provides no guarantee for a permanent adherence of the modules to the surface. OSRAM recommends fixation of the modules by means of suitable screws.
 - Complies with IEC 61347-1 cl. 18.3, cl. 18.4, IEC 60695-2-10, IEC 60695-11-5, IEC 60695-11-10 (classification V-0)
 - Module contains no PVC material.
 - To ensure uniform illumination, a reflective matt white surface is generally recommended for all internal frame walls and back panels of light boxes.
 - The module may cause noises during dimming. If a dimming operation is required, it is recommended to check the dimming operation for noises before final installation.
-











Sales and Technical Support

Sales and Technical Support www.osram.com

Download Data

File

Product family datasheet

	Brochures Technical application guide - IP codes in accordance with IEC 60529 (GB)
	Brochures Technical Application Guide BackLED PlusBasic G15 and BoxLED Plus G15 (GB)
	Brochures Impressive backlighting for signage and presentation (GB)
	Declarations of conformity EC-DoC BackLED DS Plus G15
	Declarations of conformity Manufacturer-DoC BackLED DS Plus G15
	Installation guide Instruction manual for BackLED DS Plus G15
	CAD data 3-dim LUM MONAVI WHITE 6W 845.ti
	CAD data 3-dim BA-DS-PL 865 G15 IGS File
	CAD data PDF BackLED DS Plus G15 CAD PDF
	Eulumdat BackLED DS Plus 6500K G15 Eulumdat
	IES data BackLED DS Plus 6500K G15 IES

Logistical Data

Product code	Product description	Packaging unit (Pieces/Unit)	Dimensions (length x width x height)	Volume	Gross weight
4052899245891	BA-DS-PL -865	Shipping carton box 5	440 mm x 310 mm x 207 mm	28.23 dm ³	8474.00 g

The mentioned product code describes the smallest quantity unit which can be ordered. One shipping unit can contain one or more single products. When placing an order, for the quantity please enter single or multiples of a shipping unit.

References / Links

For Guarantee see

▶ www.osram.com/guarantee

Disclaimer

Subject to change without notice. Errors and omission excepted. Always make sure to use the most recent release.