

## BoxLED Side Plus

LED modules for light advertising and backlighting



### Areas of application

- Signage and illuminated advertising
- Backlighting of single and double-sided light boxes (side lighting)
- Permanent outdoor use in enclosed light boxes

### Product benefits

- Modules are compatible with the BoxLED mounting profile
- Uniform illumination thanks to optimized elliptical lenses
- Several options for quick and simple mounting: bolting or snap-in
- Excellent module efficacy
- Very long lifetime

### Product features

- Chain of 32 linear LED modules
- Connected with flexible cables
- Maximum length of one chain: 9.60 m
- Type of protection (modules): IP66
- Special robust encapsulation
- Fully integrated heat sink



# Product family datasheet

## Technical data

### Electrical data

Product description	Nominal voltage	Nominal wattage per LED module	Rated wattage	Reverse Voltage	Input voltage range
BX06SA -W4F-765	24.0 V	3.6 W	115.20 W	25 V	23...25 V
BX06SA -W4F-840	24.0 V	3.6 W	115.20 W	25 V	23...25 V
BX06SA -W4F-830	24.0 V	3.6 W	115.20 W	25 V	23...25 V

### Photometrical data

Product description	Color temperature	Color rendering index Ra	Light color (designation)	Light color LED	Total useful luminous flux	Luminous flux per module chain
BX06SA -W4F-765	6500 K	70	Daylight	White	290 lm	9280 lm
BX06SA -W4F-840	4000 K		Cool White	White		7680 lm
BX06SA -W4F-830	3000 K		Warm White	White		7680 lm

Product description	Nominal useful luminous flux 90°	Rated useful luminous flux 90°	Luminous efficacy	Rated peak intensity	Standard deviation of color matching
BX06SA -W4F-765	219 lm	290 lm	81 lm/W	755 cd	≤4 sdcM
BX06SA -W4F-840			67 lm/W		
BX06SA -W4F-830			67 lm/W		

### Light technical data

Product description	Starting time	Rated beam angle (half peak value)	Warm-up time (60 %)	Nominal beam angle
BX06SA -W4F-765	0.0 s	12.00 ... 65.00 °	1.00 s	12 x 65 °
BX06SA -W4F-840				
BX06SA -W4F-830				

# Product family datasheet

## LED module information

Product description	Number of LEDs per module	Number of LED modules per chain	Minimum operable number of LED modules
BX06SA -W4F-765	6	32	1
BX06SA -W4F-840	6	32	1
BX06SA -W4F-830	6	32	1

## Dimensions & weight

Product description	Construction length	Rated width	Rated height	Product weight
BX06SA -W4F-765	9600.0 mm	35.0 mm	20.50 mm	1905.00 g <sup>1)</sup>
BX06SA -W4F-840	9600.0 mm			1905.00 g <sup>1)</sup>
BX06SA -W4F-830	9600.0 mm			1905.00 g <sup>1)</sup>

<sup>1)</sup> Per chain

## Product line drawing

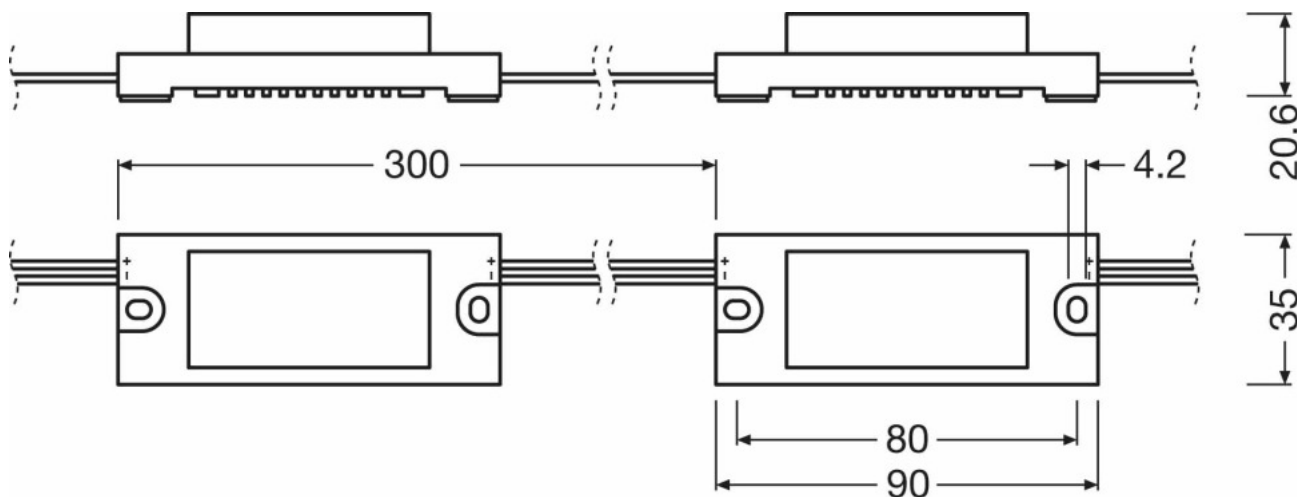

BX06SA -W4F-765, BX06SA -W4F-840, BX06SA -W4F-830

# Product family datasheet

## Temperatures & operating conditions

Product description	Temperature range in operation
BX06SA -W4F-765	-25...95 °C <sup>1)</sup>
BX06SA -W4F-840	-25...95 °C <sup>1)</sup>
BX06SA -W4F-830	-25...95 °C <sup>1)</sup>

<sup>1)</sup> At the T<sub>c</sub> point

## Lifespan

Product description	Lumen main. fact. at end of nom. life time	Nominal lamp life time	Rated lamp life time	Number of switching cycles
BX06SA -W4F-765	0.70	50000 h <sup>1)</sup>	50000 h <sup>1)</sup>	15000
BX06SA -W4F-840		50000 h <sup>1)</sup>	50000 h <sup>1)</sup>	
BX06SA -W4F-830		50000 h <sup>1)</sup>	50000 h <sup>1)</sup>	

<sup>1)</sup> At T<sub>c</sub> 95 °C

## Capabilities

Product description	Dimmable	Dimming range
BX06SA -W4F-765	Yes	5...100 %
BX06SA -W4F-840	Yes	5...100 %
BX06SA -W4F-830	Yes	5...100 %

## Certificates & standards

Product description	Energy consumption	Energy efficiency class	Type of protection
BX06SA -W4F-765	4 kWh/1000h	A+	IP66
BX06SA -W4F-840			IP66
BX06SA -W4F-830			IP66

Product description	Standards
BX06SA -W4F-765	Acc. to EC 61347-2-13/Acc. to EN 55015/Acc. to IEC 61547/Acc. to IEC 61000-3-2
BX06SA -W4F-840	Acc. to EC 61347-2-13/Acc. to EN 55015/Acc. to IEC 61547/Acc. to IEC 61000-3-2
BX06SA -W4F-830	Acc. to EC 61347-2-13/Acc. to EN 55015/Acc. to IEC 61547/Acc. to IEC 61000-3-2

# Product family datasheet

## Logistical data

Product description	Temperature range at storage
BX06SA -W4F-765	-25...85 °C
BX06SA -W4F-840	-25...85 °C
BX06SA -W4F-830	-25...85 °C

## Light Distribution

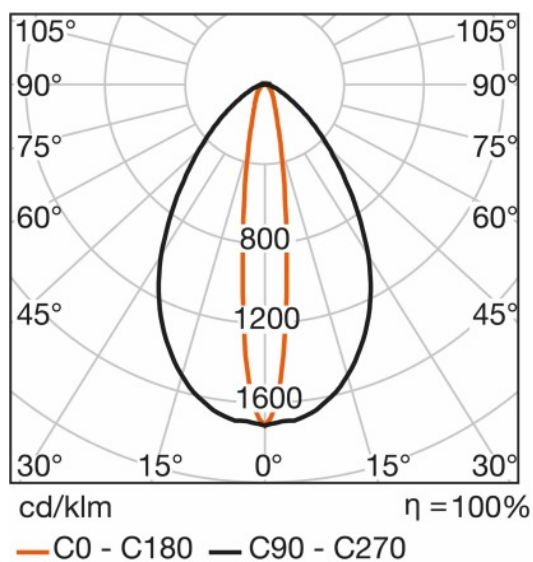

BX06SA -W4F-765, BX06SA -W4F-840, BX06SA -W4F-830

## Equipment / Accessories

- Several types of OPTOTRONIC 24 V power supplies available

## Application advice

For more detailed application information and graphics please see product datasheet.

## Additional product information

- Installation of LED modules (with power supplies) needs to be made under consideration of all valid regulations and norms.
- Installation by qualified electrician only.
- Please see the relevant application guides and instructions sheets for more detailed safety and mounting information.

## Product family datasheet

Additional information is available on request.

- Complies with IEC/EN 61547
- Complies with IEC/EN 61000-3-2
- Complies with EN 55015, CISPR 15
- Complies with IEC/EN 61347-1
- Complies with IEC/EN 61347-2-13
- LED modules are dimmable by means of PWM (pulse width modulation). It is recommended using the following OSRAM control gears: OPTOTRONIC OT DIM, OT DALI DIM or OPTOTRONIC 24 V power supplies with integrated 1...10 V dimming interface.
- Parallel connection is mandatory for safe electrical operation. Serial connection of LED modules is strongly discouraged. Unbalanced voltage drop in serial connection can cause hazardous overload and damage the LED module.
- Electrical contact is achieved with the contact cables or the terminals of the module. Please refer to the technical data for maximum number of LED modules that can be operated on one control gear.
- In order to operate OSRAM LED modules safely, it is absolutely necessary to operate them with an electronically stabilized power supply that protects against short circuits, overload and overheating.
- In case other power supplies than OSRAM OPTOTRONIC are used, compliance to the necessary operating parameters (voltage, current, power) has to be ensured.
- Pay attention to polarity! Wrong polarity can cause destruction or malfunction of the module.
- Conducting paths on the circuit board must not be damaged or destroyed during installation.
- The LED module itself and all its components must not be stressed mechanically.
- Operation in or under water is prohibited.
- To avoid mechanical damage, the LED modules have to be attached securely to the intended mounting surface. It is recommended to avoid heavy vibration.
- In case that the LED module is equipped with a pre-mounted double-sided adhesive tape, OSRAM assumes no liability and provides no guarantee for a permanent adherence of the modules to the surface. OSRAM recommends fixation of the modules by means of suitable screws.
- Complies with IEC 61347-1 cl. 18.3, cl. 18.4, IEC 60695-2-10, IEC 60695-11-5, IEC 60695-11-10 (classification V-0)
- To ensure uniform illumination, a reflective matt white surface is generally recommended for all internal frame walls and back panels of light boxes.







---

### Sales and Technical Support

Sales and Technical Support [www.osram.com](http://www.osram.com)











---

### Download Data

File	
	Brochures Technical application guide - IP codes in accordance with IEC 60529 (GB)
	Brochures Technical application guide BoxLED Side and BoxLED Side Plus (GB)
	Brochures Impressive backlighting for signage and presentation (GB)
	Declarations of conformity CE - Declaration of Conformity BoxLED Side Plus + BoxLED Back Plus
	Declarations of conformity EC-DoC BoxLED Side Plus
	Declarations of conformity Man-DoC BoxLED Side Plus

## Product family datasheet

---

	Installation guide BoxLED Side Plus
	CAD data PDF BoxLED Side Plus CAD PDF
	Eulumdat BOXLED SIDE PLUS BX06SA-W4F-765
	Eulumdat BoxLED SIDE PLUS - BX06SA-W4F-765 (.IES)
	Product Datasheet Box LED Side Plus - BX06SA (EN)
	Product Datasheet BoxLED Side Plus - BX06SA (DE)
	Eulumdat BOXLED SIDE PLUS - BX06SA-W4F-840
	Eulumdat BoxLED SIDE PLUS - BX06SA-W4F-840 (.IES)
	Eulumdat BOXLED SIDE PLUS BX06SA-W4F-830
	Eulumdat BoxLED SIDE PLUS - BX06SA-W4F-830 (.IES)

---

### Logistical Data

Product code	Product description	Packaging unit (Pieces/Unit)	Dimensions (length x width x height)	Volume	Gross weight
4008321828606	BX06SA -W4F-765	Shipping carton box 1	485 mm x 398 mm x 52 mm	10.04 dm <sup>3</sup>	2265.00 g
4008321828682	BX06SA -W4F-840	Shipping carton box 1	485 mm x 398 mm x 52 mm	10.04 dm <sup>3</sup>	2265.00 g
4008321828767	BX06SA -W4F-830	Shipping carton box 1	485 mm x 398 mm x 52 mm	10.04 dm <sup>3</sup>	2265.00 g

---

The mentioned product code describes the smallest quantity unit which can be ordered. One shipping unit can contain one or more single products. When placing an order, for the quantity please enter single or multiples of a shipping unit.

### Disclaimer

Subject to change without notice. Errors and omission excepted. Always make sure to use the most recent release.